

M8

5000 08L1 3...

Passive Actuator/Sensor Distribution Boxes M8



Passive distribution box M8, 8-port, single signal, with LEDs, IP67

Main connection:

cable, PUR, grey

M8 5000 08L1 3...

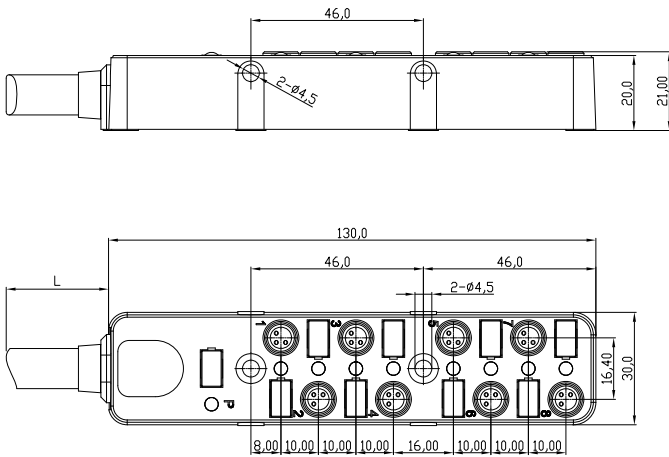

Wiring diagram

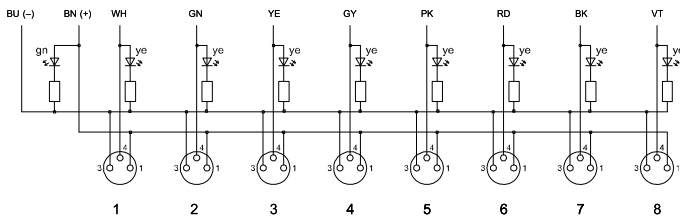

Pin assignment of female M8 connectors

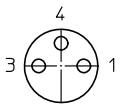

- 3 pole
- 1 +
- 3 -
- 4 S1

Environmental conditions

Temperature range -40 °C/+80 °C

Materials

Insulating body	PA, V-2 according to UL94
Contact	CuZn, pre-nickel and gold-plated
Connector thread	CuZn, nickel-plated
Housing	PC/ABS
Resistance	Good resistance against chemicals and oils. Resistance against aggressive media to be individually verified for each application.

Mechanical data











Protection class IP67¹

¹ according to DIN EN 60529, only in locked position with proper counterparts or protective caps

Electrical data (at T_{amb} 20 °C)

Contact resistance	≤ 5 mΩ
Nominal current	≤ 2 A per port ≤ 8 A total
Nominal voltage	10–30 V DC (24 V DC)

Associated products

Counterparts			
 0810 ... 0...	 0810 ... 3...	 0810 0800 ... 0...	
 0810 0800 ... 3...	 0810 0805 ... 3...	 0810 0806 ... L1 3...	
 0815 ... 0...	 0815 ... 3...		
Accessories			
 9908 CPF0	 9950 LB PF20		

M8

5000 08L1 3...

Designation	Pole Number	Connected Cable	PU (Pieces)	MDQ (Pieces)	Dimensions L (mm)
5000 08L1 308 10m	8 x 3	PUR, grey, 8 x 0.22 mm ² (AWG 24)/2 x 0.5 mm ² (AWG 21), 910308, UL-style 20549	1	1	10000
5000 08L1 308 5m	8 x 3	PUR, grey, 8 x 0.22 mm ² (AWG 24)/2 x 0.5 mm ² (AWG 21), 910308, UL-style 20549	1	1	5000

Packaging:
in a plastic bag